

HT350

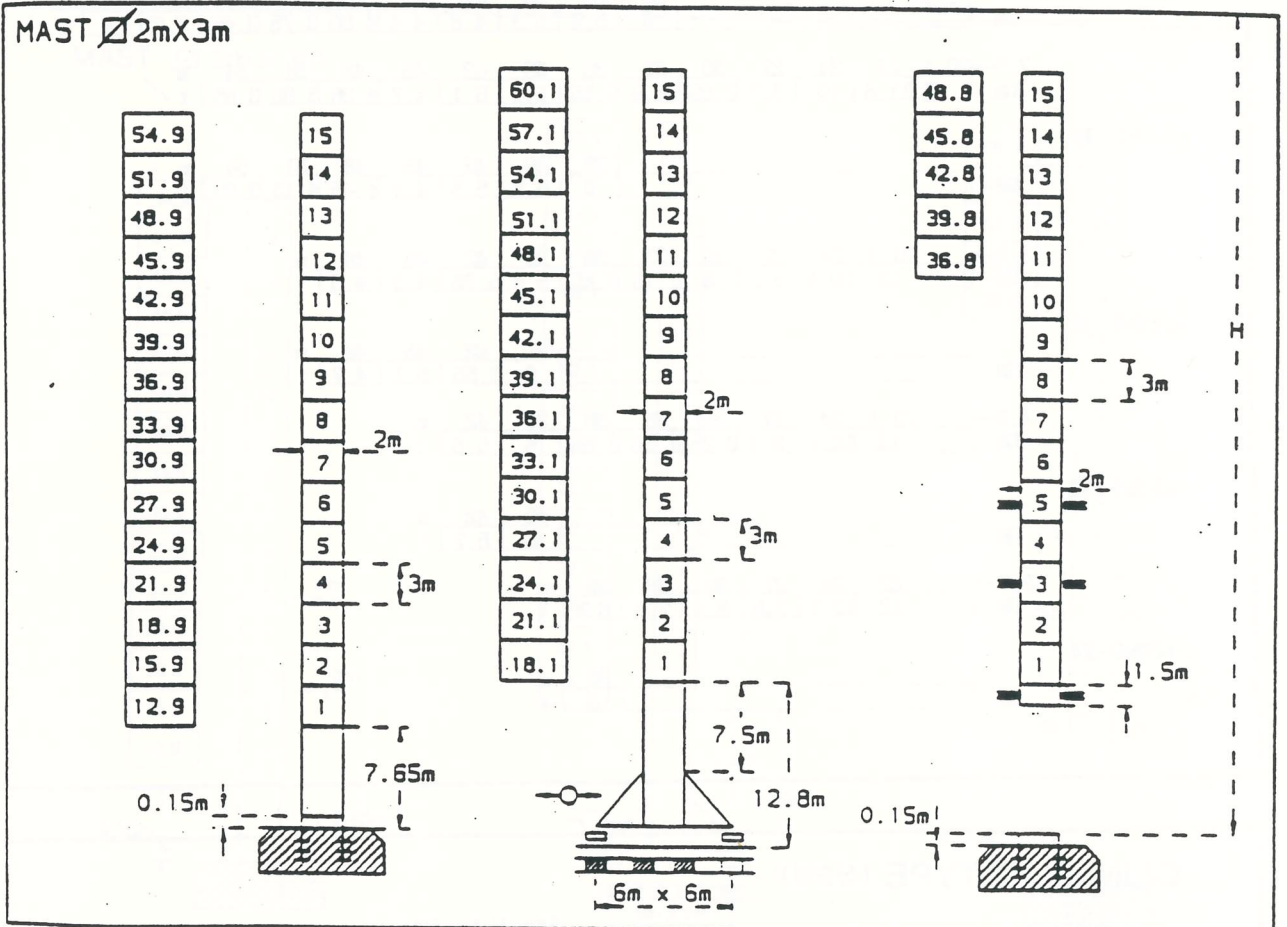
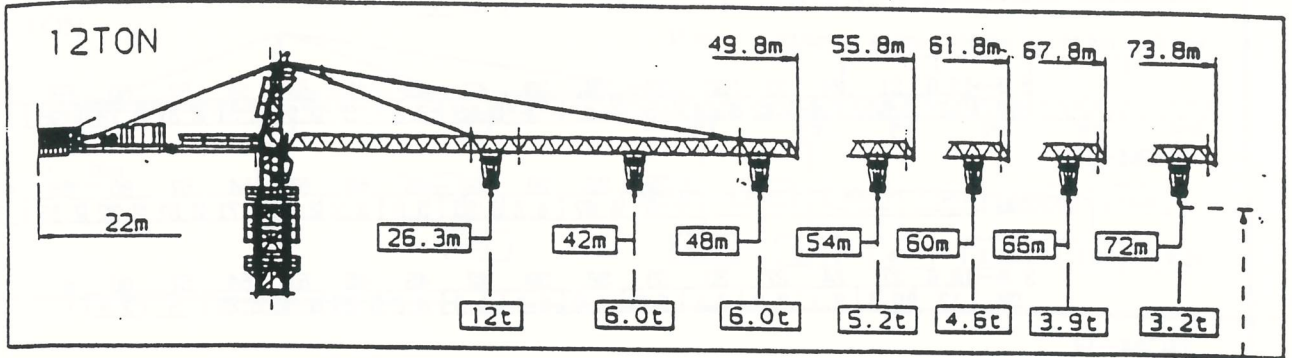

	SPEED (M/min)	MOTOR	REMARKS
SLEWING	0-0.7tr/min	2 x 7.5KW	TOTAL POWER REQUIREMENT 100KVA MAIN SUPPLY 440V/3Ph 60Hz
JIB TROLLEY	0-70 m/min	7.5KW	
TRAVELLING	0-25 m/min	4 x 3.7KW	

HOISTING MOTION		SPEED (M/min)		RATED LOAD (KG)	MOTOR
SINGLE	SM	LOW	0-34	5,000	55KW
		HIGH	0-68	3,000	
DOUBLE	DM	LOW	0-17	12,000	
		HIGH	0-34	6,000	

LOAD DISTRIBUTION (HT350)

72M-R

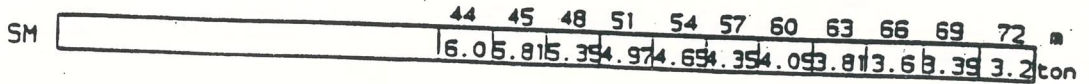
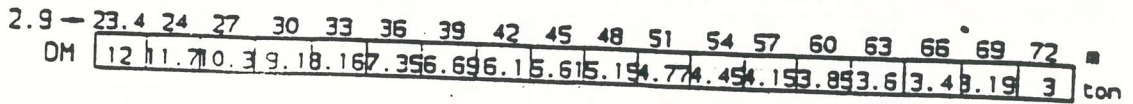

66M-R

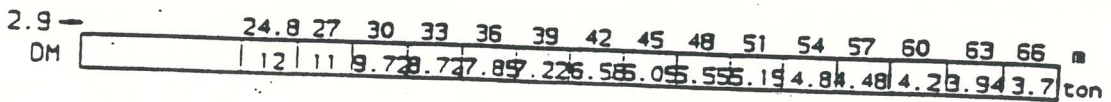

60M-R

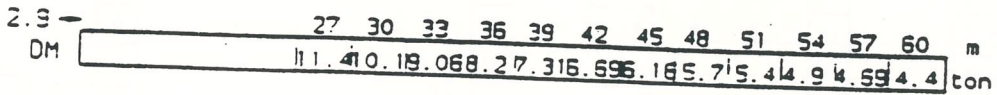

54M-R

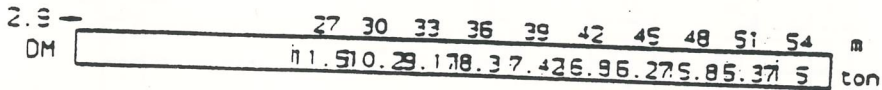

48M-R

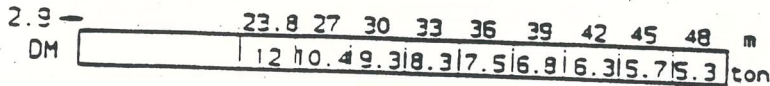

42M-R

